

国星之光 精彩照明
NATIONSTAR, LIGHTING UP THE WORLD



NATIONSTAR

ReeStar 星悦®

SPECIFICATION

Customer		Product	TOP Full-color LED
Customer No.		Type	RS-2727MWAS (旗舰版)



R&D. RGB. NATIONSTAR			CUSTOMER
APPROVE	CHECK	DRAW	CONFIRM
Version NO: A1			
Release Date: 2017.07.01			

20170701TYBA1

深圳市大靖科技有限公司

www.sz-djkj.com

专营：NATIONSTAR (国星光电) 全系列LED灯珠

原装正品，国内库存，当天发货，技术支持

电话：0755-23611637/23611737 传真：0755-23611837

RS-2727MWAS (旗舰版)

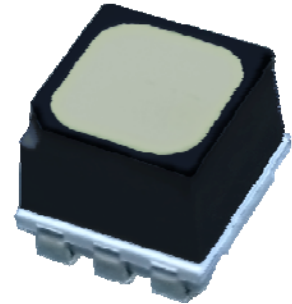

These SMD LEDs are packaged in an industry standard PLCC6 package. These high reliability and high brightness LEDs are designed to work in a wide range of environmental conditions. A wide viewing angle and high brightness make these LEDs suitable for outdoor screen, decorative lighting and amusement applications.

Features	Applications
<ul style="list-style-type: none"> • White frame around the black , High Contrast • Multiple Waterproof • Low Power Dissipation • High Luminous Intensity & High Reliability • RoHS Compliant • Pb-free Reflow Soldering Application 	<ul style="list-style-type: none"> • Outdoor Full-color Video Screen • Decorative Lighting • Amusement

1. SPECIFICATIONS

1.1 Absolute Maximum Ratings ($T_A=25^{\circ}\text{C}$)

Item	Symbol	Rating			Unit
		Red	Green	Blue	
Forward Current	I_F	30	25	25	mA
Pulse Forward Current*	I_{FP}	50			mA
Reverse Voltage	V_R	5			V
Power Dissipation	P_D	60	90	90	mW
Total Power Dissipation	P_{TOT}	90			mW
Operating Temperature	T_{OPR}	-30~+85			$^{\circ}\text{C}$
Storage Temperature	T_{STG}	-40~+100			$^{\circ}\text{C}$
Total Junction Temperature	T_J	100			$^{\circ}\text{C}$

* Note: Pulse Width $\leq 10\text{ms}$, Duty cycle $\leq 1/10$

1.2 Initial Electrical/Optical Characteristics ($T_A=25^{\circ}\text{C}$)

Item	Symbol	Condition	Color	Min.	Typ.	Max.	Unit
Reverse Current	I_R	$V_R=5\text{V}$	-	-	-	50	μA
Forward Voltage	V_F	$I_F=20\text{mA}$	Red	1.8	2.0	2.4	V
		$I_F=15\text{mA}$	Green	2.6	3.0	3.6	
		$I_F=10\text{mA}$	Blue	2.6	3.0	3.6	
Dominant Wavelength	λ_D	$I_F=20\text{mA}$	Red	615	620	630	nm
		$I_F=15\text{mA}$	Green	515	520	535	
		$I_F=10\text{mA}$	Blue	465	470	480	
Spectrum Radiation Bandwidth	$\Delta\lambda$	$I_F=20\text{mA}$	Red	-	20	-	nm
		$I_F=15\text{mA}$	Green	-	35	-	
		$I_F=10\text{mA}$	Blue	-	30	-	
Luminous Intensity	I_V	$I_F=20\text{mA}$	Red	540	820	1230	mcd
		$I_F=15\text{mA}$	Green	1160	1750	2630	
		$I_F=10\text{mA}$	Blue	180	270	410	
View Angle	$2\theta_{1/2}$	-	-	-	110	-	deg

* Note: The above data are only for reference, they come from the standard testing system of NationStar.

2. TYPICAL CHARACTERISTICS CURVES(1)

Volt-Ampere Characteristics

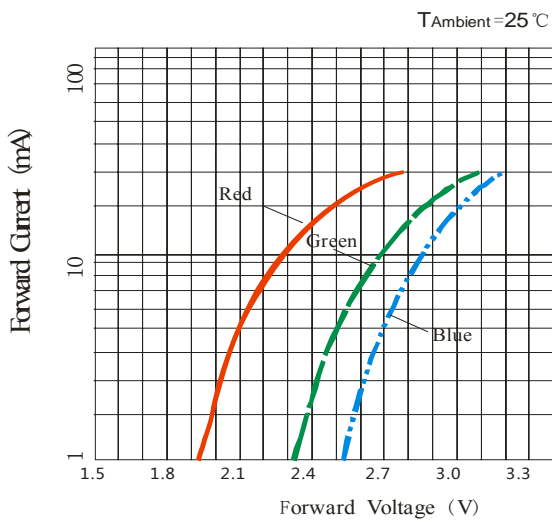

Relative Luminous Intensity VS Forward Current

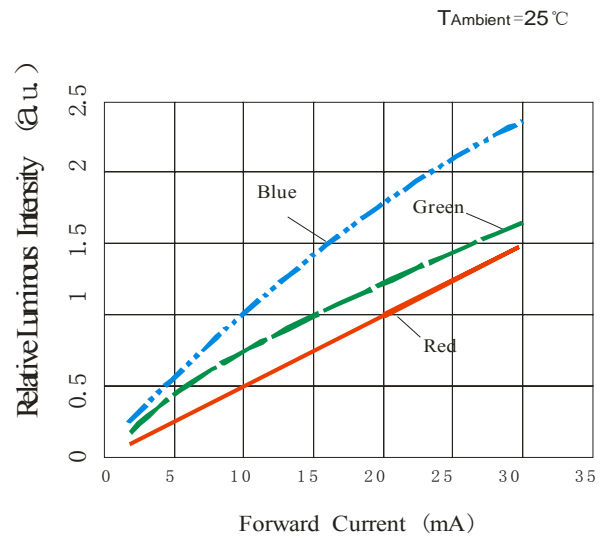

Forward Current Derating Curve

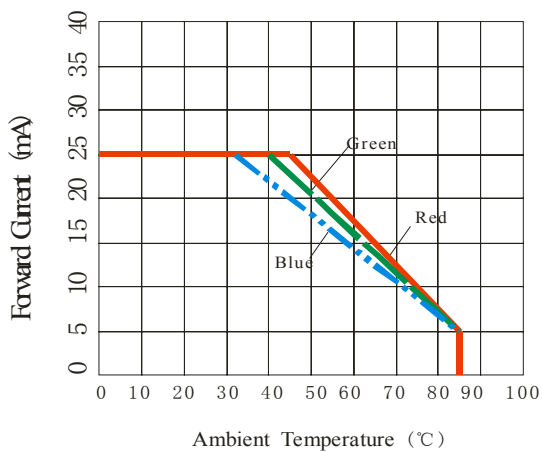

Luminous Intensity VS Ambient Temperature

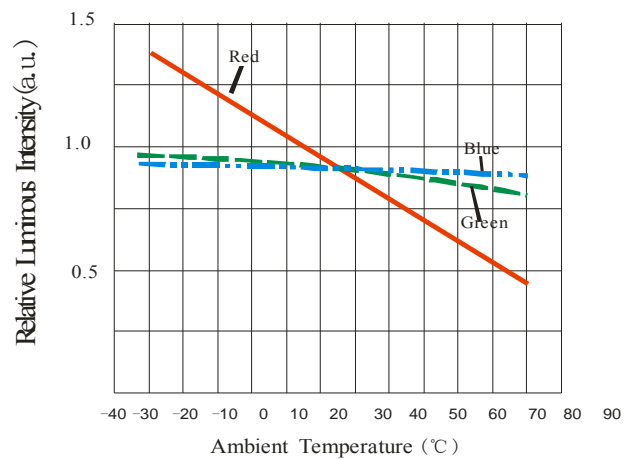

2. TYPICAL CHARACTERISTICS CURVES(2)

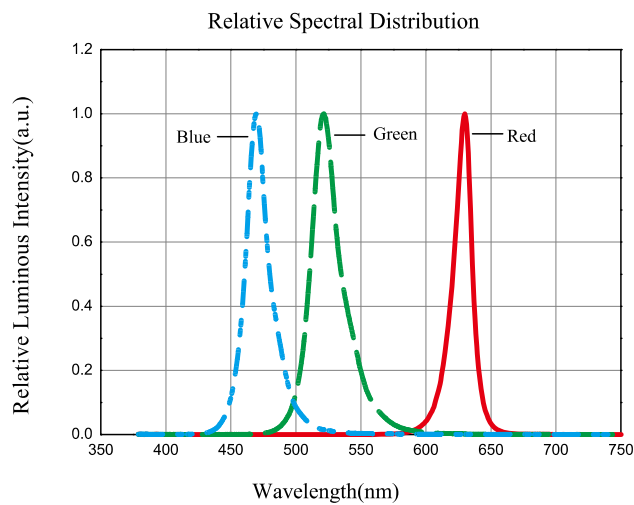
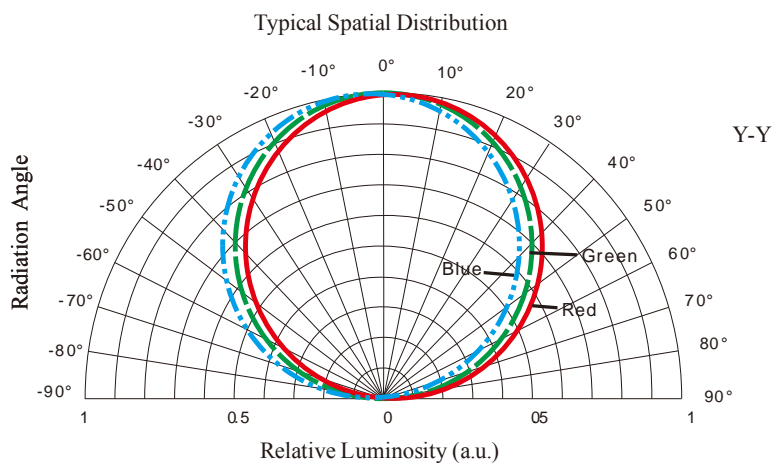
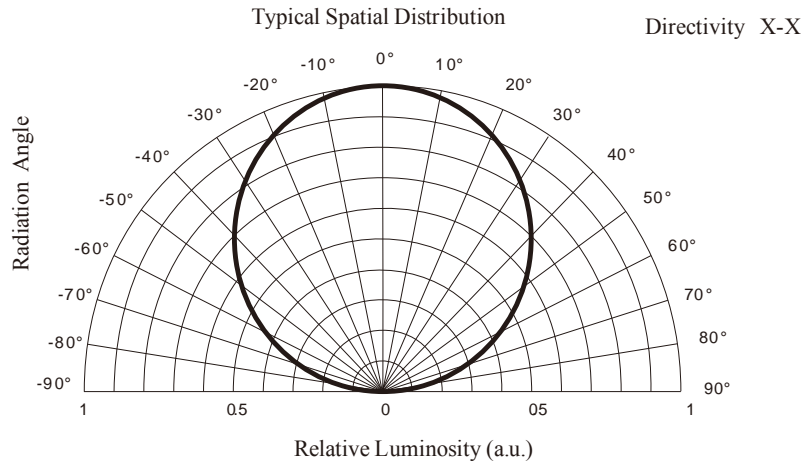

3. RELIABILITY

3.1 Test Item

Item	Reference Standard	Test Conditions	Test Duration	Failed/ Tested
Resistance to Soldering Heat*	JEITA ED-4701 300 301	$T_{sld}=(260\pm 5)^{\circ}\text{C}$, 10sec, Precondition: 30°C , 70%RH, 168hr	3 reflows	0/100
Thermal Shock	MIL-STD-202G	-40°C (30min) \leftrightarrow 100°C (30min)	300 cycles	0/100
Moisture Resistance	JEITA ED-4701 200 203	$-10\sim 65^{\circ}\text{C}$, 0~90%RH, 24hr/cycle	10 cycles	0/100
High Temperature Storage	JEITA ED-4701 200 201	$T_A=100^{\circ}\text{C}$	1000h	0/100
Low Temperature Storage	JEITA ED-4701 200 202	$T_A=-40^{\circ}\text{C}$	1000h	0/100
Temperature & Humidity Storage	JEITA ED-4701 100 103	$T_A=85^{\circ}\text{C}$, RH=85%	1000h	0/100
Room Temperature Operating Life	JESD22-A108D	$T_A=25^{\circ}\text{C}$, $I_{FR}=20\text{mA}$, $I_{FG}=15\text{mA}$, $I_{FB}=10\text{mA}$	1000h	0/100
Low Temperature Operating Life	JESD22-A108D	$T_A=-40^{\circ}\text{C}$, $I_{FR}=20\text{mA}$, $I_{FG}=15\text{mA}$, $I_{FB}=10\text{mA}$	1000h	0/100
Temperature & Humidity Operating Life	JEITA ED-4701 100 102	$T_A=60^{\circ}\text{C}$, RH=90%, $I_{FR}=20\text{mA}$, $I_{FG}=15\text{mA}$, $I_{FB}=10\text{mA}$	500h	0/100
Water Proof Test	IEC 60529:2001	Immersing in 1m water	24h	0/100
Electrostatic Discharge Test	AEC(Q101-001)	Human body model 1000 V, (Forward and reverse each 1time)	1 cycle	0/100

3.2 Failure Criteria(Value for single color)

Test Items	Symbol	Test Conditions	Criteria For Judging Damage
Forward Voltage	V_F	$I_F=I_{FT}$	Initial Data $\pm 10\%$
Reverse Current	I_R	$V_R=5\text{V}$	$I_R\leq 10\mu\text{A}$
Luminous Intensity	I_V	$I_F=I_{FT}$	Average I_V degradation $\leq 30\%$; Single LED I_V degradation $\leq 30\%$
Resistance to Soldering Heat	-	-	No dead light exists.

Note: Measurements are performed after allowing the LEDs to return to room temperature.

I_{FT} : Typical current.

4. Product design and operating recommendation

4.1 Product design (Unit: mm)

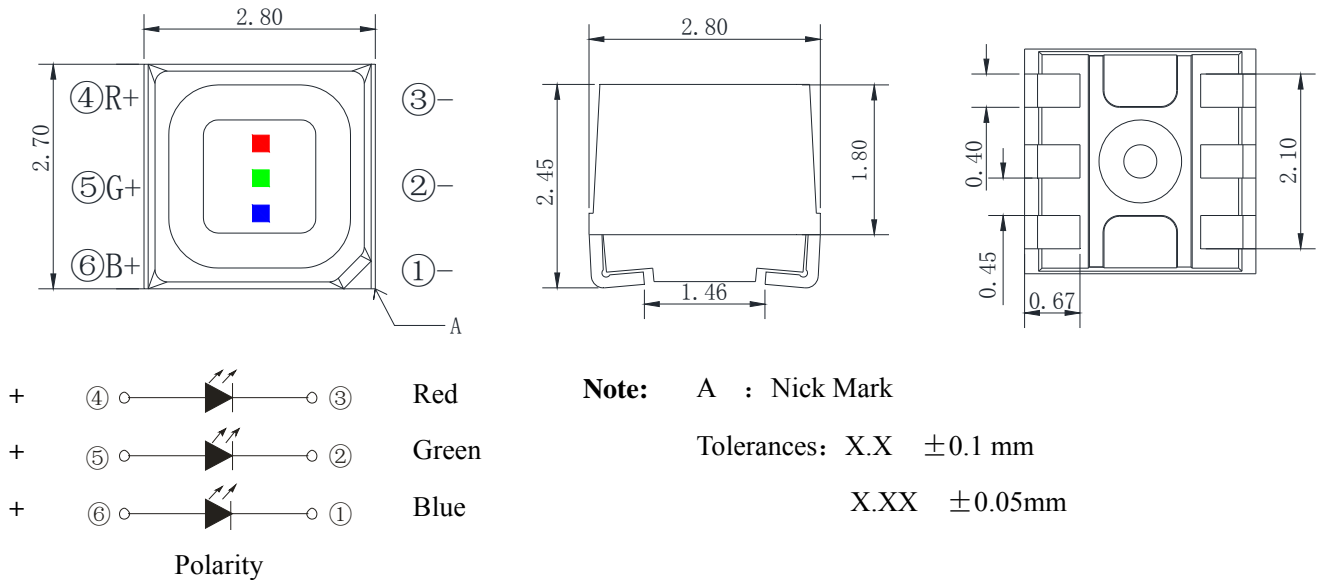

4.2 Recommended soldering pad (Unit: mm)

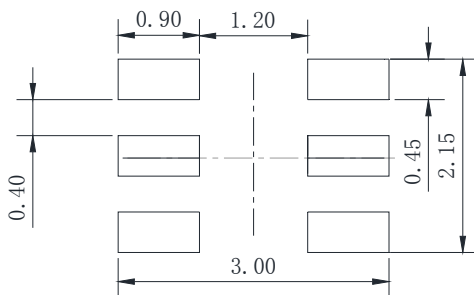

Item	Description
Package Materials	Heat-resistant Polymer
Encapsulating Resin Materials	Epoxy Resin(with diffuser)
Electrodes Materials	Ag-plated Copper Alloy

4.3 Recommendation for glue filling: filling height must be higher than or equal to 0.90 mm

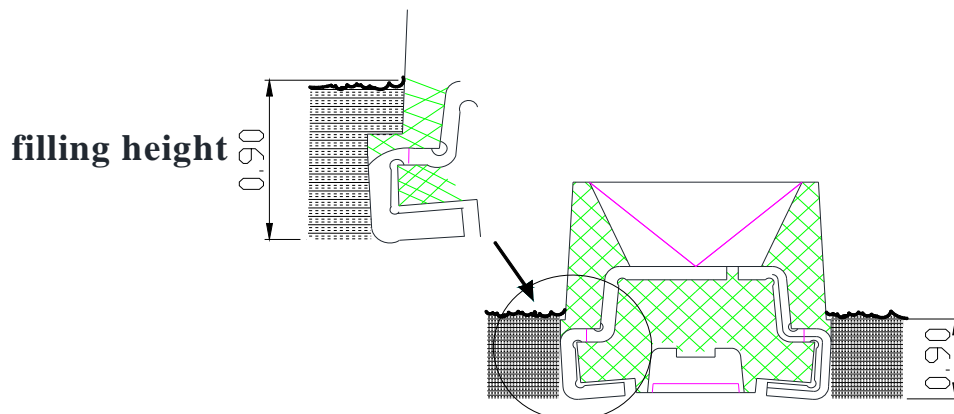

5. PACKAGING

Unit: mm, Tolerance: ± 0.1 mm

5.1 Tape

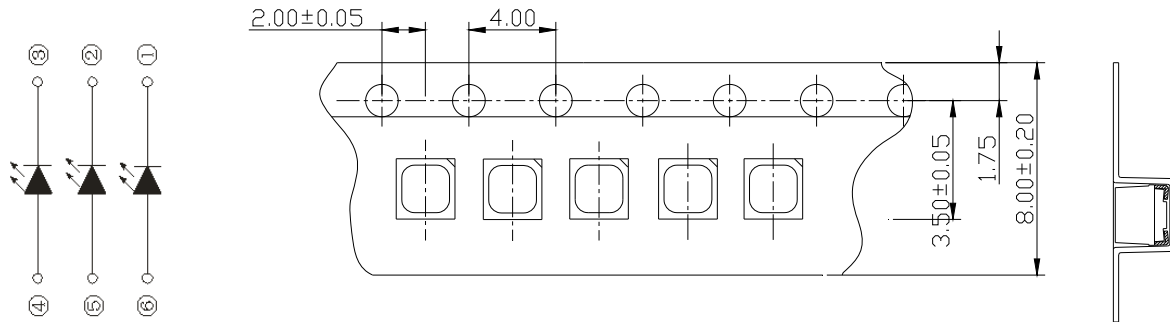

5.2 Trailer and Leader

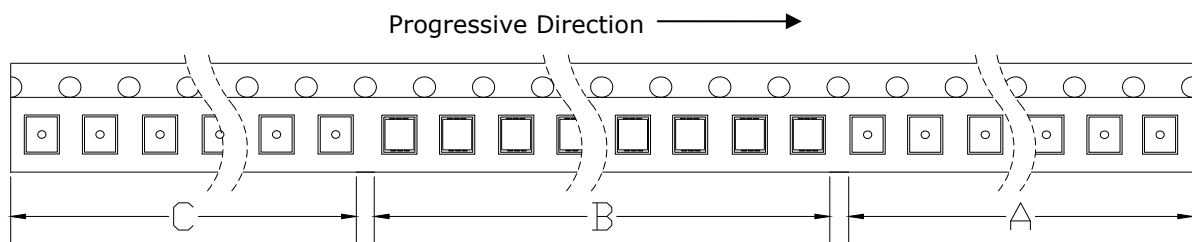

A: Leader, Empty, 500mm; B: 7000 Lamps Loaded; C: Trailer, Empty, 100mm.

5.3 Reel

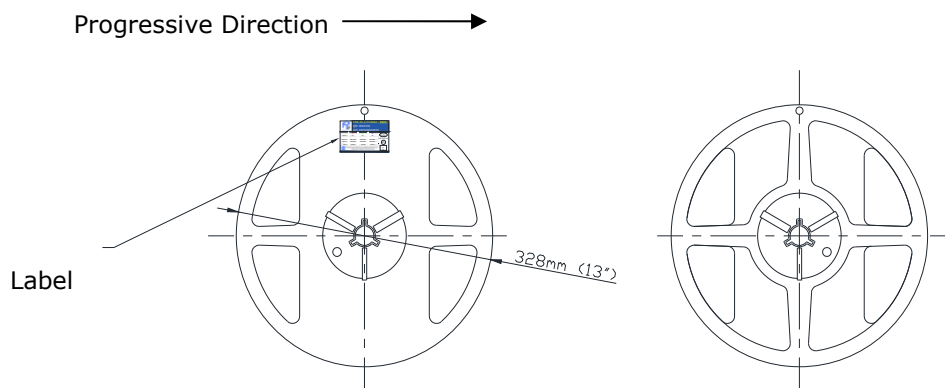

5.4 Moisture-Proof & Antistatic Foil Bag

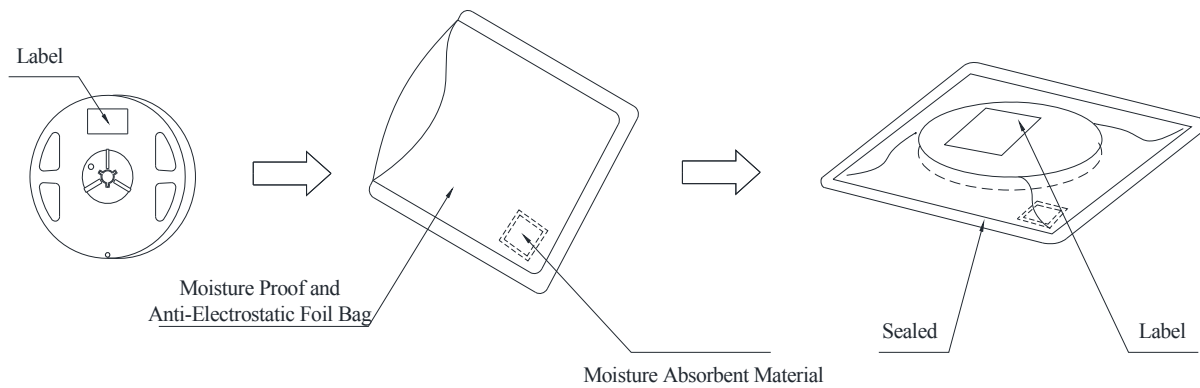

5.5 Cardboard Box

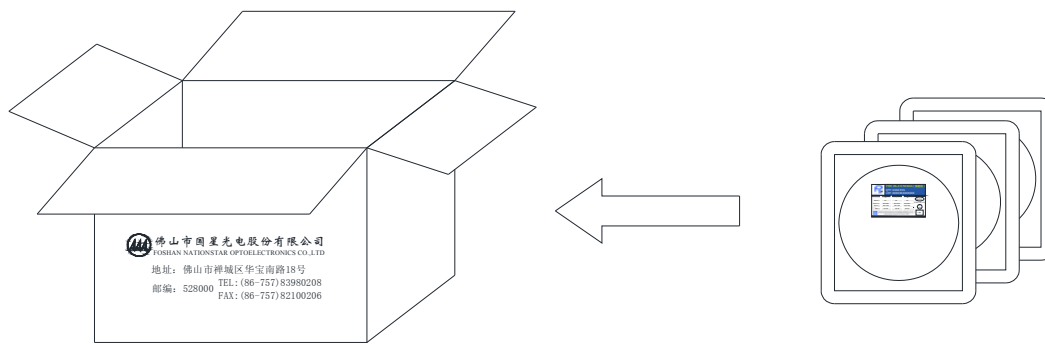

* Note: Do not drop or expose the box to external forces as it may damage the products.
 Do not expose to water. The box is not water-resistant.
 Using the original package material or equivalent in transit is recommended.

5.6 Label Explanation

TYPE:

QTY: Quantity

BIN: Rank

SC: Bin Code

LOT: Lot Number

λ d: Wavelength Range

IV: Luminous Intensity Range

VF: Forward Voltage Range

IF: Test Current

	R	G	B	
IF(mA) :	XX	XX	XX	RoSH
IV(mcd) :	XXX-XXX	XXX-XXX	XXX-XXX	XXXX-XX-XX
λ d(nm) :	XXX-XXX	XXX-XXX	XXX-XXX	QC PASS
VF(V) :	XX-XX	XX-XX	XX-XX	二维码

TYPE: RS-XXXXXXXXX
QTY: XXXX PCS
LOT: XXXXXXXXXXXXX
FOSHAN NATIONSTAR OPTOELECTRONICS CO.,LTD
 Automotive Grade Full Color LED

6. GUIDELINE FOR SOLDERING

6.1 Recommended Hand Soldering Condition

Temperature	315°C Max
Soldering Time	2sec Max

- The package materials of the LED should not contact the soldering tool.
- When Soldering, do not apply stress to the surface resin.
- Hand soldering must not be performed more than once.

6.2 Recommended Reflow Soldering Condition(Lead-free Solder):

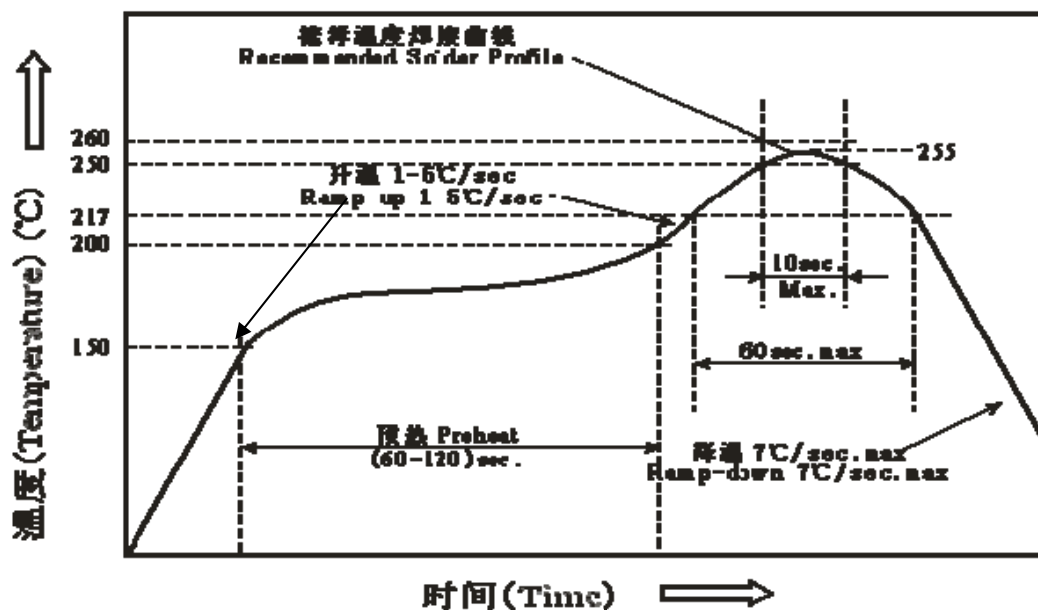

- This LED is designed to be reflow soldered on to PCB. If dip soldered, we cannot guarantee its reliability.
- Reflow soldering must not be performed more than twice.
- Stress on the LEDs should be avoided during heating in soldering process.
- When soldering, do not apply stress to the LED while the LED is hot.
- Nitrogen reflow soldering is recommended. Air flow soldering conditions can cause optical degradation, caused by heat or atmosphere.
- Repairing should not be done after the LEDs have been soldered. When repairing is unavoidable, a double-head soldering iron should be used.(It should be confirmed beforehand whether the characteristics of the LEDs will or will not be damaged by repairing.)
- When using a pick and place machine, choose an appropriate nozzle for this product.
- This product can differ in optical characteristics depending on both the number of reflow cycles and reflow temperature conditions.

7. CAUTIONS

7.1 Storage

Products Storage Situation	Baking Condition	SMT Production Period
Within 2 months (undamped)	(70±5) °C×12h	24h
After 2 months (undamped)	(70±5) °C×24h	
Damped/Foiled bag leakage/ beyond 6 months' storage at customers' side	(70±5) °C×48h	
Note: All the products should be stored in the environment of temperature<30°C and humidity<60% RH before foiled bags open and need to be baked before SMT.		

- Product complies with JEDEC MSL 3 or equivalent, See IPC/JEDEC STD-020 for moisture-sensitivity details.
- Absorbed moisture in LED packages can vaporize and expand during soldering, which can cause interface delamination and result in optical performance degradation. Products are packed in moisture-proof aluminum bags to minimize moisture absorption during transportation and storage. Included silica gel desiccants change from brown to blue if moisture had penetrated bags.
- After opening the moisture-proof aluminum bag, the products should go through the soldering process within the range of the conditions stated above. Unused remaining LEDs should be stored with silica desiccants in a hermetically sealed container.
- If the aluminum bag has leaked air before opening or the "Period After Opening" storage time has been exceeded, the products should be baked. Baking should only be done once and the reel should out of the aluminum bag when baking.
- Although the leads or electrode pads(anode and cathode)of the product are plated with Ag, prolonged exposure to corrosive environment might cause the Ag plated the leads or electrode pads to tarnish, and thus leading to difficulties in soldering. If unused LEDs remain, they must be stored in a hermetically sealed container.
- Do not use sulfur-containing materials in commercial products. Some materials, such as seals and adhesives, may contain sulfur. The contaminated plating of LEDs might cause an open circuit. Silicone rubber is recommended as a material for seals.
- To prevent water condensation, please avoid large temperature and humidity fluctuations for the storage conditions.
- Do not expose the LEDs to direct sunlight and/or an environment where the temperature is higher than normal room temperature.

7.2 Directions for Use

- In designing a circuit, the current through each LED die must not exceed the Absolute Maximum Rating current specified for each die. It is recommended that each LED die is driven at a constant current.
- When having the two or more die within this product on at the same time, the total power dissipation for the LED package must be within the absolute maximum value specified in this specification.
- This product should be operated using forward current. Ensure that the product is not subjected to either forward or reverse voltage while it is not in use. In particular, subjecting it to continuous reverse voltage may cause migration, which may cause damage to the LED die. When used in displays that are not used for a long time, the main power supply should be switched off for safety.
- Care must be taken to ensure that the reverse voltage will not exceed the Absolute Maximum Rating when using the LEDs with matrix drive.
- Ensure that excessive voltages such as lightning surges are not applied to the LEDs.
- Aging is recommended for detecting manufacturing and assembly defects. In particular, ensure that excessive current and/or voltage is not applied to the LEDs. This aging should be conducted in environments where water condensation does not occur.
- It is recommended to operate the LEDs at a current greater than 10% of the sorting current to stabilize the LED characteristics.
- This product can be used in indoor applications; however, when the LEDs are used in the following environments, incorporate sufficient measures into the display to prevent debris, water/moisture and gases that will adversely affect the product.
 - where water vapor is abundant, where water condensation is likely to occur
 - where water is likely to splash on to the LEDs
 - where frost is likely to form on the surface of the LEDs(e.g. freezer, ice skating rink, etc)
 - where dust, dirt, debris, loose metallic materials and/or gases that will adversely affect the product are present
- In areas where hydrogen sulfide, which is a sulfide-based gas, is present(e.g. hot springs and volcanic areas), and where salt is abundant(e.g. coastal areas), the life may be shortened.
- When this product is used for displays that will be installed outside: the LEDs should be covered to avoid exposure to outdoor environments in conjunction with sufficient measures against direct sunlight, wet or damp conditions, and salt damage.
- When power is applied for the first time after installation, the display should not be powered an 100% wattage since the LEDs may have absorbed moisture. Before normal use of this display, operate the display at approximately 20% wattage for an initial time period.
- If the display units will be rented, those unites should be selected carefully to ensure that the display as a whole will appear the same color and brightness.
- If the display units are loaded onto and/or transported by ship, the damp environment on the vessel will cause condensation; the display units should be packaged to prevent moisture absorption.
- If a display that has been, or is being, used is relocated, it is possible that degradation of the LED has occurred. When transporting this display, provide sufficient protection for the LEDs in addition to the moisture-proof packaging for the display. When this display is reinstalled, ensure to follow the installation instructions for environments and use.

7.3 Handling Precautions

- Do not handle the LEDs with bare hands as it will contaminate the LED surface and may affect the optical characteristics: it might cause the LED to be deformed and/or the wire to break, which will cause the LED not to illuminate. The lead could also cause an injury.
- When handling the product with tweezers, be careful not to apply excessive force to the resin. Otherwise, the resin can be cut, chipped, delaminate or deformed, causing wire-bond breaks and catastrophic failures.
- Dropping the product may cause damage.
- Do not stack assembled PCBs together. Failure to comply can cause the resin portion of the product to be cut, chipped, delaminated and/or deformed. It may cause wire to break, leading to catastrophic failures.

7.4 Design Consideration

- PCB warpage after mounting the products onto a PCB can cause the package to break. The LED should be placed in a way to minimize the stress on the LEDs due to PCB bow and twist.
- The position and orientation of the LEDs affect how much mechanical stress is exerted on the LEDs placed near the score lines. The LED should be placed in a way to minimize the stress on the LEDs due to board flexing.
- Board separation must be performed using special jigs, not using hands.

7.5 Electrostatic Discharge(ESD)

- The products are sensitive to static electricity or surge voltage. ESD can damage a die and its reliability. When handling the products, the following measures against electrostatic discharge are strongly recommended:
 - Eliminating the charge
 - Grounded wrist strap, ESD footwear, clothes, and floors
 - Grounded workstation equipment and tools
 - ESD table/shelf mat made of conductive materials
- Ensure that tools (e.g. soldering irons), jigs and machines that are being used are properly grounded and that proper grounding techniques are used in work areas. For devices/equipment that mount the LEDs, protection against surge voltages should also be used.
- If tools or equipment contain insulating materials such as glass or plastic, the following measures against electrostatic discharge are strongly recommended:
 - Dissipating static charge with conductive materials
 - Preventing charge generation with moisture
 - Neutralizing the charge with ionizers
- The customer is advised to check if the LEDs are damaged by ESD, when performing the characteristics inspection of the LEDs in the application. Damage can be detected with a forward voltage measurement or a light-up test at low current ($\leq 1\text{mA}$).
- LEDs with ESD-damaged dice (i.e. other than red) may have an increased leakage current, current flow at a low voltage, or no longer illuminate at a low current. Failure criteria: $V_F < 2.0\text{V}$ at $I_F = 0.5\text{mA}$.

7.6 Thermal Management

- Proper thermal management is an important when designing products with LEDs. LED die temperature is affected by PCB thermal resistance and LED spacing on the board. Please design products in a way that the LED die temperature does not exceed the maximum junction temperature (T_J).
- Drive current should be determined for the surrounding ambient temperature (T_A) to dissipate the heat from the product.

7.7 Cleaning

- The LEDs should not be cleaned with water, benzene, and/or thinner.
- If required, isopropyl alcohol (IPA) should be used. Other solvents may cause premature failure to the LEDs due to the damage to the resin portion. The effects of such solvents should be verified prior to use. In addition, the use of CFCs such as Freon is heavily regulated.
- When dust and/or dirt adheres to the LEDs, soak a cloth with Isopropyl alcohol (IPA), then squeeze it before wiping the LEDs.
- Ultrasonic cleaning is not recommended since it may have adverse effects on the LEDs depending on the ultrasonic power and how LED is assembled. If ultrasonic cleaning must be used, the customer is advised to make sure the LEDs will not be damaged prior to cleaning.

7.8 Eye Safety

- Please proceed with caution when viewing directly any LEDs driven at high current, or viewing LEDs with optical instruments which may greatly increase the damages to your eyes.
- Viewing a flashing light may cause eye discomfort. When incorporating the LED into your product, please be careful to avoid adverse effects on the human body caused by light stimulation.

7.9 Others

- The LEDs described in this brochure are intended to be used for ordinary electronic equipment (such as office equipment, communications equipment, measurement instruments and household appliances). Consult NATIONSTAR's sales staff in advance for information on the applications in which exceptional quality and reliability are required, particularly when the failure or malfunction of the LEDs may directly jeopardize life or health (such as for airplanes, aerospace, submersible repeaters, nuclear reactor control system, automobiles, traffic control equipment, life support systems and safety devices).
- The customer shall not reverse engineer by disassembling or analysis of the LEDs without having prior written consent from NATIONSTAR. When defective LEDs are found, the customer shall inform NATIONSTAR directly before disassembling or analysis.
- The specifications and appearance of this specification. Both the customer and NATIONSTAR will agree on the official specifications of supplied products before the volume production of a program begins.