

### ● Description

The KT0480 series photo coupler contains a LED and photo detector with built-in Schmitt trigger to provide logic-compatible waveforms, eliminating the need for additional wave shaping. The totem pole output eliminates the need for a pull up resistor and allows for direct drive Intelligent Power Module or gate drive. Minimized propagation delay difference between devices makes these photo couplers excellent solutions for improving inverter efficiency through reduced switching dead time.

### ● Features

1. Positive output type (totem pole output)
2. Truth Table Guaranteed: VCC from 4.5V to 30V
3. Performance Specified for Common IPM Applications Over Industrial Temperature Range.
4. Short Maximum Propagation Delays
5. Minimized Pulse Width Distortion (PWD)
6. Very High Common Mode Rejection (CMR)
7. Hysteresis

### ● Applications

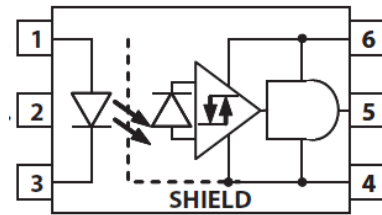
- T IPM Interface Isolation
- Isolated IGBT/MOSFET Gate Drive
- AC and Brushless DC Motor Drives
- Industrial Inverters
- General Digital Isolation

### ● Truth Table

LED	OUT
ON	H
OFF	L

Note: A 0.1μF bypass capacitor must be connected between Pin 4 and 6.

### ● Schematic

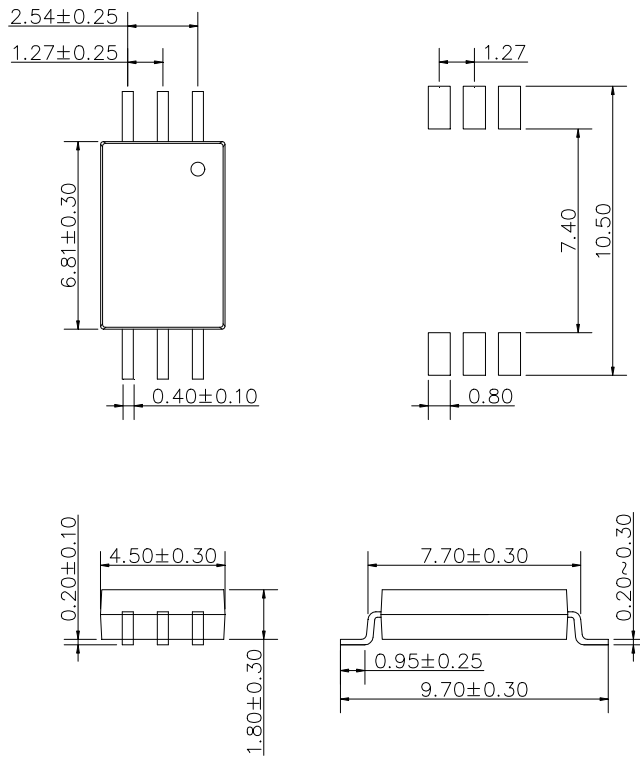


- |            |                        |
|------------|------------------------|
| 1. Anode   | 4. GND                 |
| 2. N.C.    | 5. Vo (Voltage Output) |
| 3. Cathode | 6. Vcc                 |

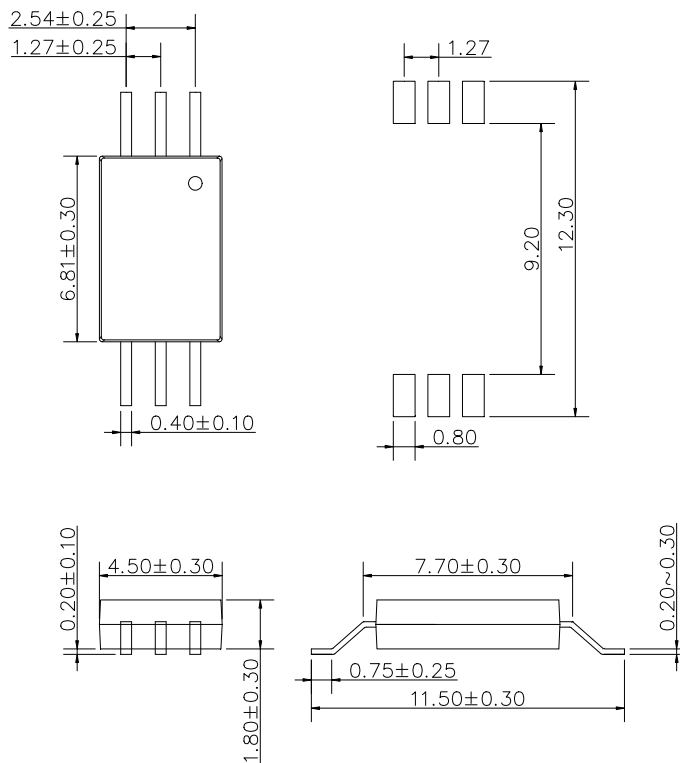
● **Outside Dimension**

Unit : mm

**P Type**



**W Type**



### ● Device Marking



#### Notes:

**COSMO**  
0480  
YWW  
V

Y: Year code / WW: Week code  
V or None : VDE option

### ● Absolute Maximum Ratings

(Ta = 25°C)

Parameter		Symbol	Rating	Unit
Input	Forward current	$I_F$	20	mA
	Peak transient forward current (Note 1)	$I_{FPT}$	1	A
	Reverse voltage	$V_R$	5	V
Output	Output current	$I_O$	50	mA
	Output voltage	$V_O$	35	V
	Supply Voltage	$V_{CC}$	35	V
Junction temperature		$T_j$	125	°C
Storage Temperature		$T_{stg}$	-55~125	°C
Operating Temperature		$T_{opr}$	-40~110	°C
Total Package Power Dissipation		$P_T$	145	mW
Lead soldering temperature(10s) (Note 2)		$T_{sol}$	260	°C
Isolation voltage (AC, 1min., R.H ≤ 60%) (Note 3)		BVs	5000	Vrms
Input-Output Resistance ( $V_{I-O} = 500V$ DC) (Note 3)		$R_{I-O}$	$10^{12}$	$\Omega$

Note 1: Pulse width  $P_w \leq 1\mu s, 300pps$ .

Note 2: It is 2 mm or more from a lead root.

Note 3: Device is considered as a two terminal device: Pin1,2 and 3 shorted together, and pins 4,5 and 6 shorted together.

### ● Recommend Operation Conditions

Parameter	Symbol	Min.	Max.	Unit
Operating Temperature	$T_A$	-40	110	°C
Supply Voltage <sup>1</sup>	$V_{CC}$	4.5	30	V
Input Current (ON) <sup>2</sup>	$I_{F(ON)}$	1.6	5	mA
Input Voltage (OFF)	$V_{F(OFF)}$		0.8	V

Note 1: Detector requires a VCC of 4.5 V or higher for stable operation as output might be unstable if VCC is lower than 4.5 V. Be sure to check the power ON/OFF operation other than the supply current.

Note 2: The initial switching threshold is 1.6 mA or less. It is recommended that 2.2 mA be used to permit at least a 20% LED degradation guard band.

### ● Electrical Characteristics

( $T_a = 25^\circ\text{C}$ )

Parameter	Symbol	Test Condition	Min.	Typ.	Max.	Unit	
Input Forward Voltage	$V_F$	$I_F = 10\text{mA}$	1.6	2.0	2.4	V	
Input Forward Voltage Temperature Coefficient	$\Delta V_F / \Delta T$	$I_F = 10\text{mA}$	-	-1.237	-	mV/°C	
Input Reverse Voltage	$BV_R$	$I_R = 10\mu\text{A}$	5	-	-	V	
Input Threshold Current (Low to High)	$I_{FLH}$	$V_{CC} = 30\text{V}, V_O > 5\text{V}$	-	0.2	1.5	mA	
Input Threshold Voltage (High to Low)	$V_{FHL}$	$V_{CC} = 30\text{V}, V_O < 5\text{V}$	0.8	-	-	V	
Input Capacitance	$C_{IN}$	$f = 1\text{MHz}, V_F = 0\text{V}$	-	60	-	pF	
Supply Current	High Level	$I_{CCH}$	$V_{CC} = 5.5\text{V}, I_F = 5\text{mA}, I_O = 0\text{mA}$	-	-	3.0	mA
			$V_{CC} = 30\text{V}, I_F = 5\text{mA}, I_O = 0\text{mA}$		1.9	3.0	
	Low Level	$I_{CCL}$	$V_{CC} = 5.5\text{V}, V_F = 0\text{V}, I_O = 0\text{mA}$	-	-	3.0	
			$V_{CC} = 30\text{V}, V_F = 0\text{V}, I_O = 0\text{mA}$		2.0	3.0	
Output current	High level	$I_{OH}$	$V_{CC} = 5.5\text{V}, I_F = 5\text{mA}, V_O = \text{GND}$	-	-	-160	mA
			$V_{CC} = 20\text{V}, I_F = 5\text{mA}, V_O = \text{GND}$	-	-	-200	
	Low level	$I_{OL}$	$V_O = V_{CC} = 5.5\text{V}, V_F = 0\text{V}$	160	-	-	
			$V_O = V_{CC} = 20\text{V}, V_F = 0\text{V}$	200	-	-	
Output voltage	High level	$V_{OH}$	$I_{OL} = -6.5\text{mA}$	$V_{CC} - 0.5$	$V_{CC} - 0.04$	-	V
	Low level	$V_{OL}$	$I_{OL} = 6.5\text{mA}$	-	0.09	0.5	

Specified over recommended temperature ( $T_A = -40^\circ\text{C}$  to  $+110^\circ\text{C}$ ,  $4.5\text{V} \leq V_{CC} \leq 30\text{V}$ ),  $I_{F(ON)} = 1.6\text{mA}$  to  $5\text{mA}$ ,  $V_{F(OFF)} = 0\text{V}$  to  $0.8\text{V}$ , unless otherwise specified. All typicals at  $T_A = 25^\circ\text{C}$ .

Note 1: Duration of output short circuit time should not exceed  $10\mu\text{s}$ .

Note 2: Input capacitance is measured between pin 1 and pin 3.

### ● Switching Characteristics

(Ta = 25°C)

Parameter	Symbol	Test Condition	Min.	Typ.	Max.	Unit
Propagation Delay Time to Output Low Level	$t_{PHL}$	f = 10kHz, Duty Cycle = 50%  I <sub>F</sub> = 2mA, V <sub>CC</sub> = 30V	-	110	220	ns
Propagation Delay Time to Output High Level	$t_{PLH}$		-	90	220	
Pulse Width Distortion	PWD		-	20	120	
Propagation Delay Difference Between Any Two Parts	PDD ( $t_{PHL} - t_{PLH}$ )		-200	-	+200	
Rise Time	$t_r$		-	6	-	
Fall Time	$t_f$		-	7	-	
Common mode transient immunity at high level output	C <sub>MH</sub>	I <sub>F</sub> =4.0 mA V <sub>CC</sub> = 5V, T <sub>A</sub> = 25 °C, V <sub>CM</sub> = 1.5KV	20	—	—	KV / μs
Common mode transient immunity at low level output	C <sub>ML</sub>	I <sub>F</sub> =0mA V <sub>CC</sub> = 5V, T <sub>A</sub> = 25 °C, V <sub>CM</sub> = 1.5KV	20	—	—	KV / μs

Over recommended operating conditions TA = -40° C to 105° C, VCC = +4.5 V to 30 V, IF(ON) = 1.6 mA to 5 mA, VF(OFF) = 0 V to 0.8 V, unless otherwise specified. All typicals at TA = 25°C.

Note 1: The tPLH propagation delay is measured from the 50% point on the leading edge of the input pulse to the 1.3 V point on the leading edge of the output pulse. The tPHL propagation delay is measured from the 50% point on the trailing edge of the input pulse to the 1.3 V point on the trailing edge of the output pulse.

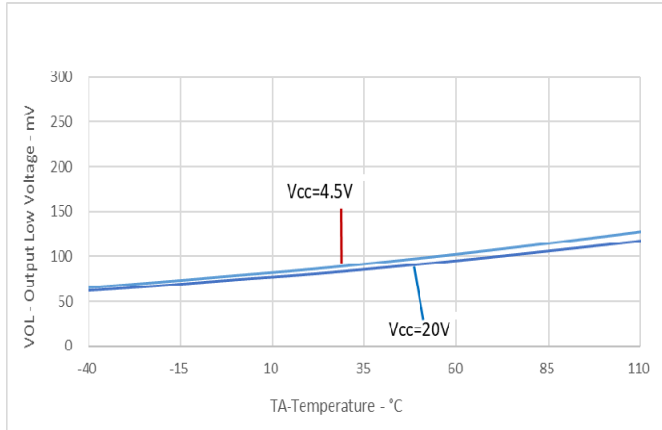
Note 2: Pulse Width Distortion (PWD) is defined as |tPHL - tPLH| for any given device.

Note 3: The difference of tPLH and tPHL between any two devices under the same test condition.

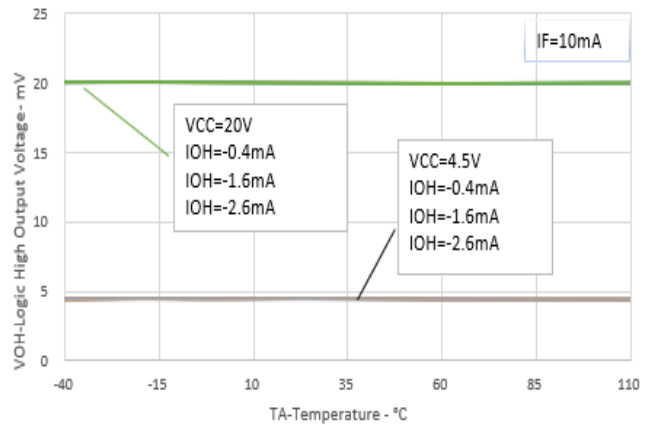
Note 4: CMH is the maximum slew rate of the common mode voltage that can be sustained with the output voltage in the logic high state, VO > 2.0 V. CML is the maximum slew rate of the common mode voltage that can be sustained with the output voltage in the logic low state, VO < 0.8 V. Note: Equal value split resistors (Rin/2) must be used at both ends of the LED.

**TYPICAL PERFORMANCE CURVES & TEST CIRCUITS**

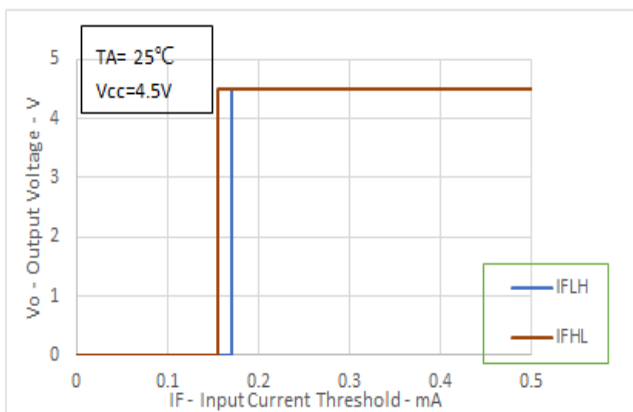
**Fig.1 VOL vs. Temperature**



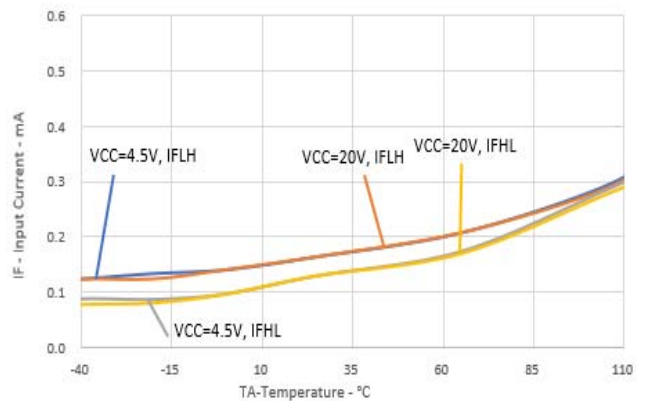
**Fig.2 V<sub>OH</sub> vs. Temperature**



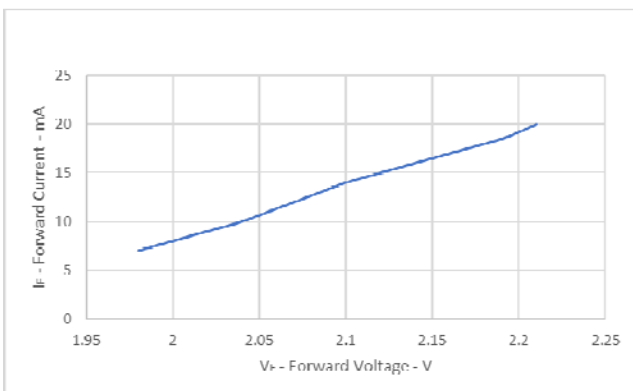
**Fig.3 I<sub>FLH</sub> Hysteresis**



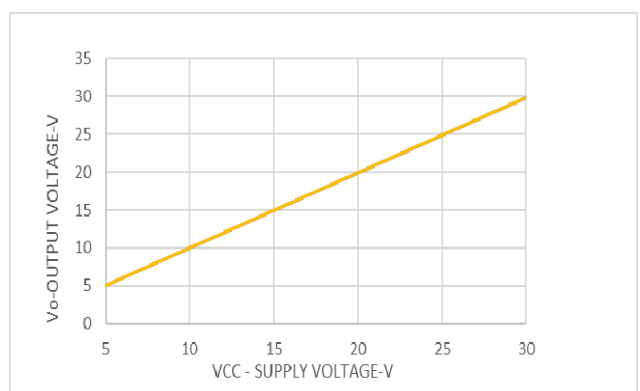
**Fig.4 I<sub>FLH</sub> vs. Temperature**



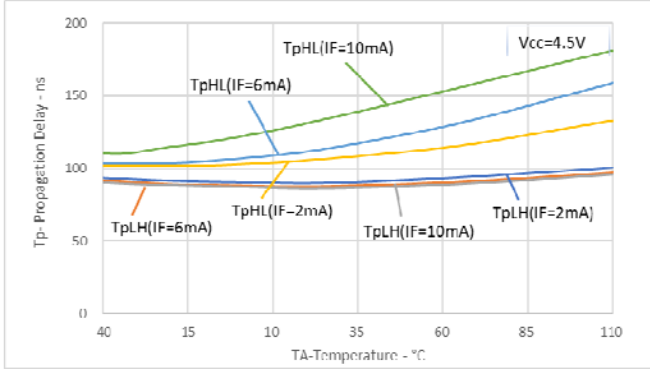
**Fig.5 Input Current vs. Voltage**



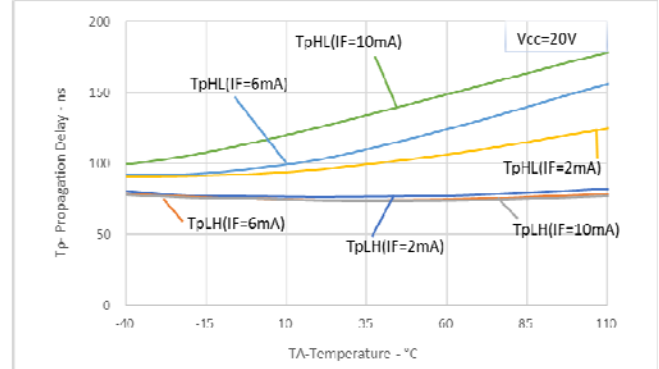
**Fig. 6 Supply Voltage vs. Output Voltage**



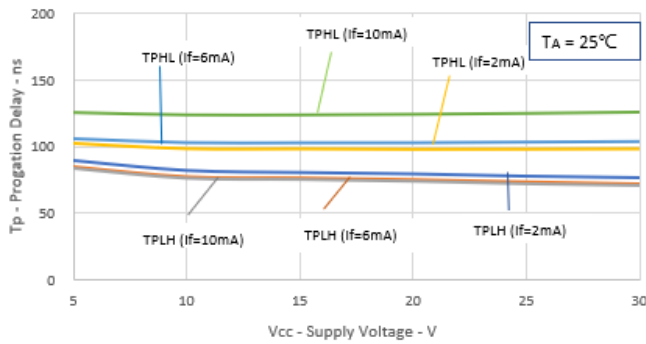
**Fig.7 Propagation Delays vs. Temperature**



**Fig.8 Propagation Delays vs. Temperature**

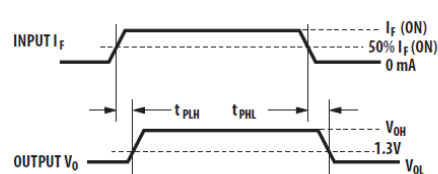
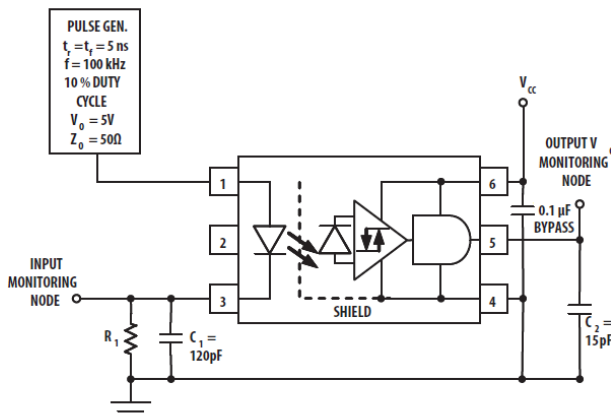


**Fig.9 Propagation Delays vs. Vcc**

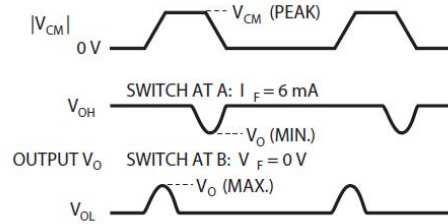
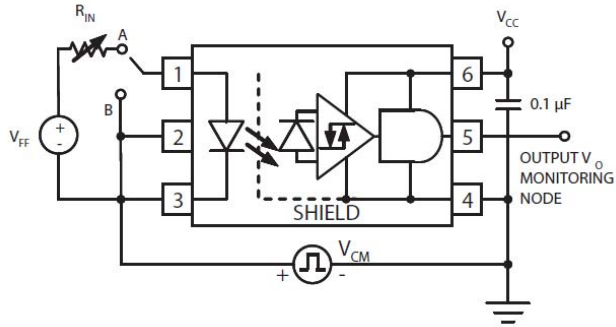


● **Test Circuit**

**Propagation delay time  $t_{PLH}$ 、 $t_{PHL}$ 、and rise time  $t_r$ , fall time  $t_f$**



**Common Mode Transient Immunity Test Circuit and Typical Waveforms**



\* $C_{ML}(C_{MH})$  is the maximum rate of rise (fall) of the common mode voltage that can be sustained with the output voltage in the low (high) state.

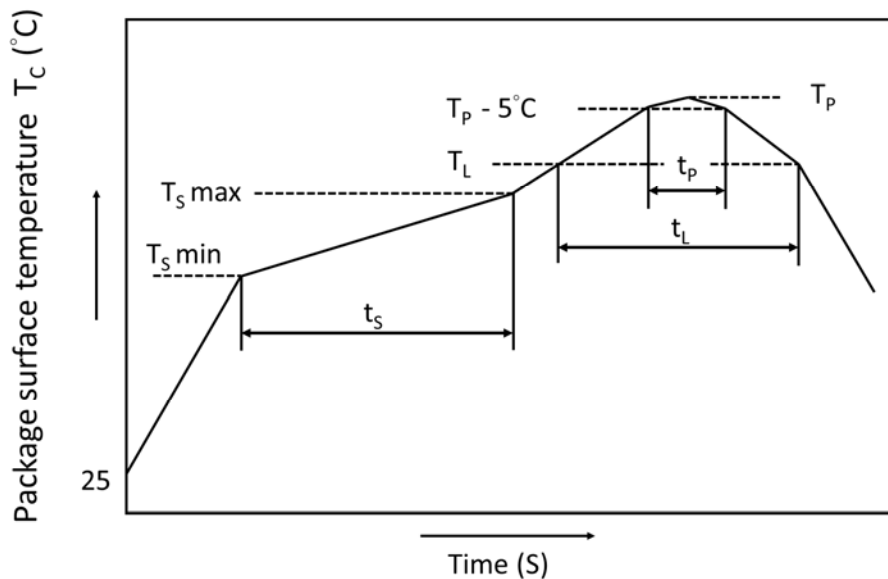


## ● Recommended Soldering Conditions

IR Reflow soldering

One time soldering reflow is recommended within the condition of temperature and time profile shown below. Do not solder more than three times.

### Recommended Temperature Profile of Infrared Reflow



	Symbol	Min	Max	Unit
Preheat temperature	$T_S$	150	200	°C
Preheat time	$t_S$	60	120	s
Ramp-up rate ( $T_L$ to $T_P$ )			3	°C/s
Liquidus temperature	$T_L$	217		°C
Time above $T_L$	$t_L$	60	100	s
Peak Temperature	$T_P$		260	°C
Time during which $T_C$ is between ( $T_P - 5$ ) and $T_P$	$t_P$		20	s
Ramp-down rate			6	°C/s

- **Numbering System**

## KT0480 X (Y)-(Z)

**Notes:**

KT0480 = Part No.

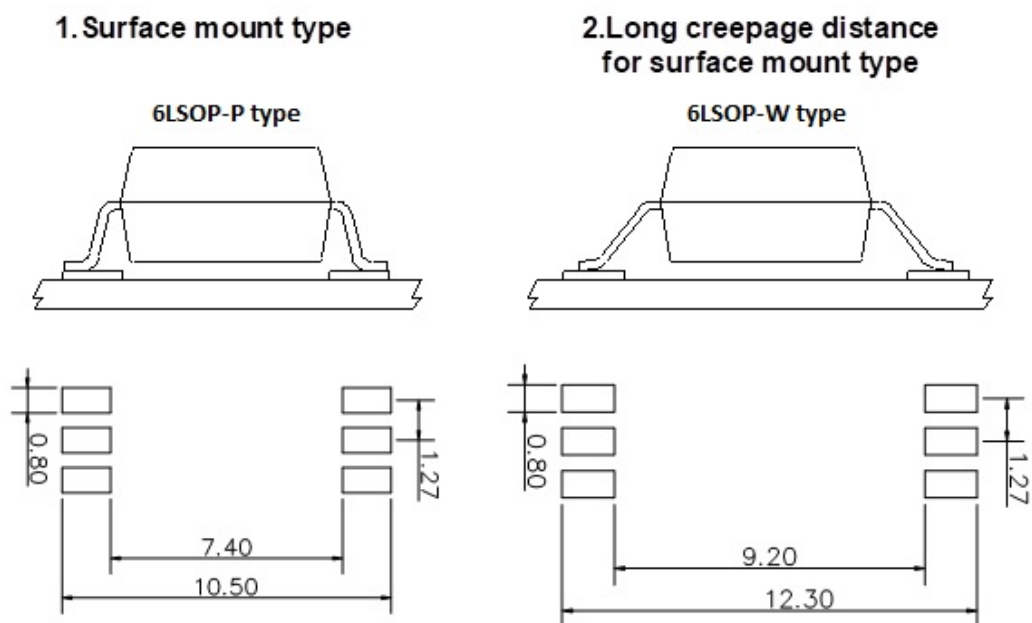
X = Lead form option (P or W )

Y = Tape and reel option (TLD or TRU)

Z = VDE option (V or None)

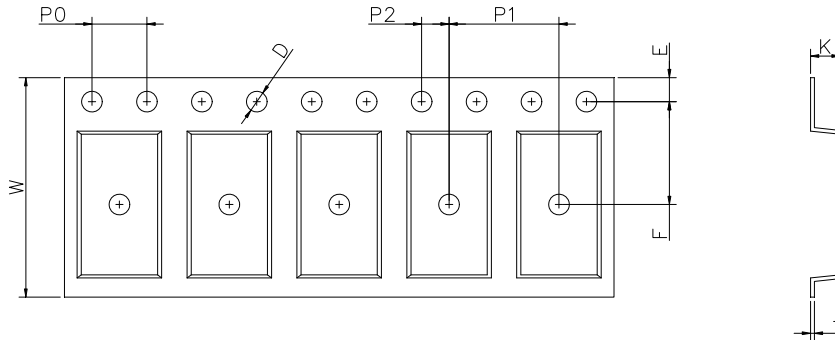
Option	Description	Packing quantity
P (TLD)	surface mount type package + TL tape & reel option	3000 units per reel
P (TRU)	surface mount type package + TR tape & reel option	3000 units per reel
W (TLD)	long creepage distance for surface mount type package + TLD tape & reel option	3000 units per reel
W (TRU)	long creepage distance for surface mount type package + TRU tape & reel option	3000 units per reel

- **Recommended Pad Layout for Surface Mount Lead Form**



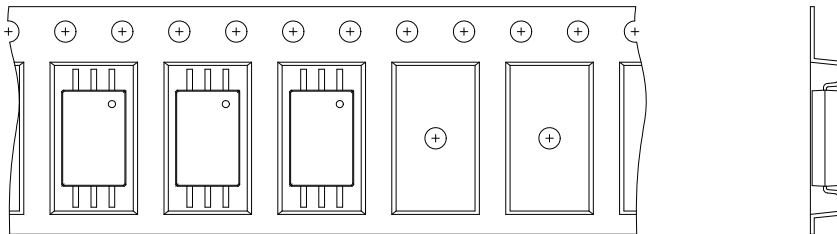
Unit :mm

● **LSOP 6 Carrier Tape & Reel**

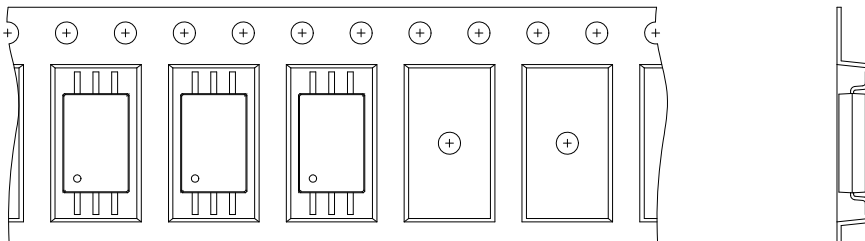


Dimension Symbol	D	E	F	P0	P1	P2	t	W	K
P type Dimension (mm)	1.5±0.1	1.75±0.1	7.5±0.1	4.0±0.1	8.0±0.1	2.0±0.1	0.3±0.1	16.0±0.3	2.15±0.1
W type Dimension (mm)	1.5±0.1	1.75±0.1	11.5±0.1	4.0±0.1	8.0±0.1	2.0±0.1	0.3±0.1	24.0±0.3	2.52±0.1

TRU



TLD



- **Application Notice**

The statements regarding the suitability of products for certain types of applications are based on cosmo's knowledge of general applications of cosmo products. Such statements are not binding statements about the suitability of products for a particular application. It is the customer's responsibility to verify the specifications are suitable for use in a particular application. Customers are solely responsible for all aspects of their own product design or applications. The parameters provided in the datasheet may vary in different applications and performance may vary over time. All operating parameters (including typical parameters) must be validated by customer's technical experts for different applications. cosmo assumes no liability for customer' product design or applications. Product specifications do not expand or otherwise change cosmo's terms and conditions of purchase, including but not limited to the warranty expressed therein.

When using cosmo products, please comply with safety standards and instructions. cosmo has no liability and responsibility to the damage caused by improper use of the instructions specified in the specifications.

cosmo products are designed for use in general electronic equipment such as telecommunications, office automation equipments, personal computers, test and measurement equipments, consumer electronics, industrial control, instrumentation, audio, video.

cosmo devices shall not be used in equipment that requires higher level of reliability and safety, such as nuclear power control equipment, telecommunication equipment(trunk lines), space application, medical and other life supporting equipments, and equipment for aircraft, military, automotive or any other application that can cause human injury or death.

cosmo reserves the right to change the specifications, data, characteristics, structure, materials and other contents at any time without notice. Please contact cosmo to obtain the latest specification.

cosmo disclaim any and all liability for any errors, inaccuracies or incompleteness contained in any datasheet or in any other disclosure relating to any product.