

### ● Description

The KPC611 series consist of an LED optically coupled to an OPIC chip. It is a high-speed digital output type photo coupler designed specifically for low circuit current. And it is packaged in a 5pin mini-flat package.

### ● Schematic

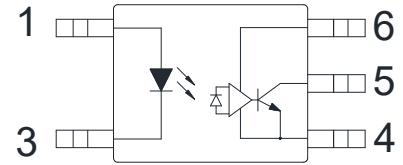

- 1. Anode
- 3. Cathode
- 4. GND
- 5. Vo
- 6. Vcc

### ● Features

- Pb free and RoHS compliant
- Dual voltage operation (3.3V/5V)
- 10 kV/μs minimum Common Mode Rejection (CMR) at VCM = 1000V (3.3V operating voltage)
- High speed: 10 MBd typical
- LVTTL/LVCMOS compatible
- Low input current capability: 5 mA
- Guaranteed AC and DC performance over temperature: -40°C to +110°C
- Agency Approvals:
  - UL Approved
  - c-UL Approved
  - VDE Approved

### ● Applications

- Isolated line receiver
- Computer-peripheral interfaces
- Microprocessor system interfaces
- Digital isolation for A/D, D/A conversion
- Switching power supply
- Instrument input/output isolation
- Ground loop elimination
- Pulse transformer replacement
- Field buses

● **Outside Dimension**

Unit : mm

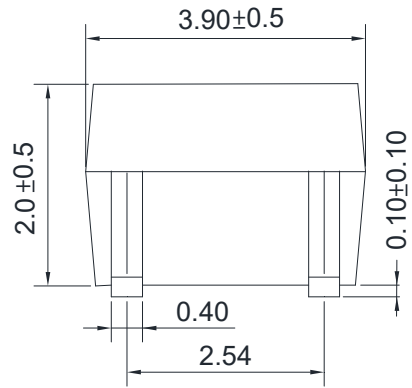
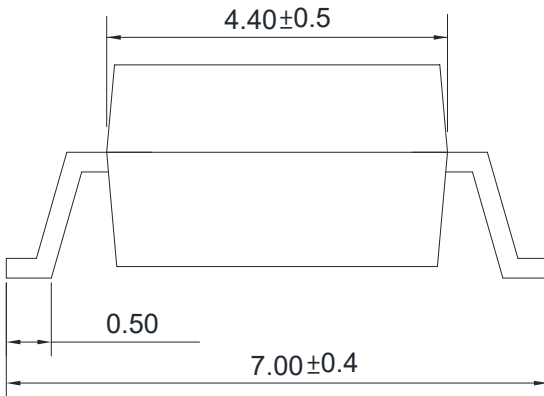
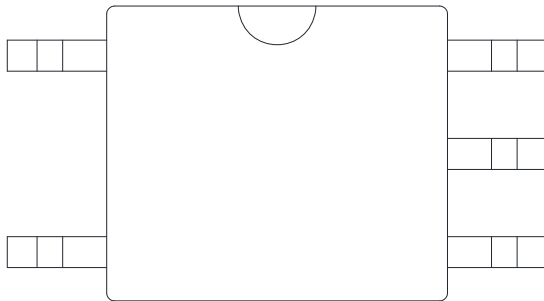

TOLERANCE: ±0.2mm

● **Device Marking**



**Notes:**

cosmo  
611  
YWW

Y: Year code / WW: Week code



# KPC611 Series

## 5PIN HIGH-SPEED OUTPUT PHOTOCOUPLER

● **Absolute Maximum Ratings**

(Ta=25°C)

Parameter		Symbol	Rating	Unit
Input	Forward current	$I_F$	25	mA
	Peak forward current (1)	$I_{FM}$	40	mA
	Reverse voltage	$V_R$	5	V
	Power dissipation	$P_D$	45	mW
Output	Supply voltage	$V_{CC}$	7	V
	High level output voltage	$V_{OIL}$	7	V
	Low level output current	$I_{OL}$	50	mA
	Output collector power dissipation	$P_C$	85	mW
Isolation voltage (2)		Viso	3750	Vrms
Operating temperature		Topr	-40 to +110	°C
Storage temperature		Tstg	-55 to +125	°C
Soldering temperature 10 seconds		Tsol	260	°C

Note 1: Pulse width (PW) ≤ 1 ms, duty = 50 %

Note 2: This device is considered as a two-terminal device: Pins 1 and 3 are shorted together, and pins 4, 5 and 6 are shorted together.

### ● Electro-optical Characteristics

Over recommended operating condition ( $T_A = -40^{\circ}\text{C}$  to  $+110^{\circ}\text{C}$ ,  $2.7\text{V} \leq V_{DD} \leq 3.6\text{V}$ ) unless otherwise specified.

All Typical specifications at  $V_{CC} = 3.3\text{V}$ ,  $T_A = 25^{\circ}\text{C}$ .

Parameter	Symbol	Conditions	Min.	Typ.	Max.	Unit
Input forward voltage	$V_F$	$I_F=10\text{mA}$	-	1.35	1.7	V
Input reverse voltage	$V_{BR}$	$I_R=10\mu\text{A}$	5	-	-	V
Input capacitance	$C_{IN}$	$V_F=0$ , $f=1\text{MHz}$	-	60	-	pF
High Level Output Current	$I_{OH}$	$V_{CC}=3.3\text{V}$ , $V_O=3.3\text{V}$ , $V_F=0.8\text{V}$	-	2	10	$\mu\text{A}$
Low Level Output Voltage	$V_{OL}$	$V_{CC}=3.3\text{V}$ , $I_F=7.5\text{mA}$ , $I_{OL}(\text{Sinking})=13\text{mA}$	-	0.3	0.5	V
High Level Supply Current	$I_{CCH}$	$V_{CC}=3.3\text{V}$ , $I_F=0\text{mA}$	-	3	7	mA
Low Level Supply Current	$I_{CCL}$	$V_{CC}=3.3\text{V}$ , $I_F=10\text{mA}$	-	3	7	mA
Input Threshold Current	$I_{TH}$	$T_A = -40^{\circ}\text{C}$ to $85^{\circ}\text{C}$ $V_{CC} = 3.3\text{V}$ , $V_O = 0.6\text{V}$ , $I_{OL}(\text{Sinking}) = 13\text{mA}$	-	2.5	5	mA
Isolation resistance (input-output) (3)	$R_{I-O}$	$V_{I-O}=500\text{V}$	-	$10^{12}$	-	$\Omega$
Capacitance (input-output) (3)	$C_{I-O}$	$f=1\text{MHz}$	-	0.6	-	pF

Over recommended temperature ( $T_A = -40^{\circ}\text{C}$  to  $+110^{\circ}$ ,  $4.5\text{V} \leq V_{DD} \leq 5.5\text{V}$ ) unless otherwise specified.

All Typical specifications at  $V_{CC} = 5\text{V}$ ,  $T_A = 25^{\circ}\text{C}$ .

Parameter	Symbol	Conditions	Min.	Typ.	Max.	Unit
Input forward voltage	$V_F$	$I_F=10\text{mA}$	-	1.35	1.7	V
Input reverse voltage	$V_{BR}$	$I_R=10\mu\text{A}$	5	-	-	V
Input capacitance	$C_{IN}$	$V_F=0$ , $f=1\text{MHz}$	-	60	-	pF
High Level Output Current	$I_{OH}$	$V_{CC}=5\text{V}$ , $V_O=5\text{V}$ , $V_F=0.8\text{V}$	-	2	10	$\mu\text{A}$
Low Level Output Voltage	$V_{OL}$	$V_{CC}=5\text{V}$ , $I_F=7.5\text{mA}$ , $I_{OL}(\text{Sinking})=13\text{mA}$	-	0.2	0.4	V
High Level Supply Current	$I_{CCH}$	$V_{CC}=5\text{V}$ , $I_F=0\text{mA}$	-	4	7	mA
Low Level Supply Current	$I_{CCL}$	$V_{CC}=5\text{V}$ , $I_F=10\text{mA}$	-	4	7	mA
Input Threshold Current	$I_{TH}$	$V_{CC} = 5\text{V}$ , $V_O = 0.6\text{V}$ , $I_{OL} > 13\text{mA}$	-	3	5	mA
Isolation resistance (input-output) (3)	$R_{I-O}$	$V_{I-O}=500\text{V}$	-	$10^{12}$	-	$\Omega$
Capacitance (input-output) (3)	$C_{I-O}$	$f=1\text{MHz}$	-	0.6	-	pF

Note 3: This device is considered as a two-terminal device: Pins 1 and 3 are shorted together, and pins 4, 5 and 6 are shorted together

- **Switching Specifications**

Over recommended temperature ( $T_A = -40^{\circ}\text{C}$  to  $+110^{\circ}\text{C}$ ),  $V_{CC} = 3.3\text{V}$ ,  $I_F = 7.5\text{ mA}$  unless otherwise specified.  
All Typical specifications at  $T_A = 25^{\circ}\text{C}$ .

Parameter	Symbol	Conditions	Min.	Typ.	Max.	Unit
Propagation delay time to high output level	$t_{PLH}$	$I_F=7.5\text{mA}, V_{CC}=3.3\text{V}, R_L=350\Omega,$ $C_L=15\text{pF}$	-	60	90	ns
Propagation delay time to low output level	$t_{PHL}$		-	45	70	ns
Pulse Width Distortion	$ t_{PHL} - t_{PLH} $		-	-	30	ns
Propagation Delay Skew	$t_{PSK}$		-	-	30	ns
Rise time	$t_r$	$I_F=7.5\text{mA}, V_{CC}=3.3\text{V}, R_L=350\Omega,$ $C_L=15\text{pF}$	-	30	-	ns
Fall time	$t_f$		-	5	-	ns
High level Common Mode Transient Immunity	$CM_H$	$I_F=0\text{mA}, V_{CC}=3.3\text{V}$ $V_{CM}=10\text{V}, V_O(\text{Min})=2.0\text{V}$ $R_L=350\Omega$	10,000	-	-	V/us
Low level Common Mode Transient Immunity	$CM_L$	$I_F=7.5\text{mA}, V_{CC}=3.3\text{V}$ $V_{CM}=10\text{V}, V_O(\text{Max})=0.8\text{V}$ $R_L=350\Omega$	10,000	-	-	V/us

Over recommended temperature ( $T_A = -40^{\circ}\text{C}$  to  $+110^{\circ}\text{C}$ ),  $V_{CC} = 5\text{ V}$ ,  $I_F = 7.5\text{ mA}$  unless otherwise specified.  
All Typical specifications at  $T_A = 25^{\circ}\text{C}$ .

Parameter	Symbol	Conditions	Min.	Typ.	Max.	Unit
Propagation delay time to high output level	$t_{PLH}$	$I_F=7.5\text{mA}, V_{CC}=5\text{V}, R_L=350\Omega,$ $C_L=15\text{pF}$	-	60	90	ns
Propagation delay time to low output level	$t_{PHL}$		-	50	70	ns
Pulse Width Distortion	$ t_{PHL} - t_{PLH} $		-	-	30	ns
Propagation Delay Skew	$t_{PSK}$		-	-	30	ns
Rise time	$t_r$	$I_F=7.5\text{mA}, V_{CC}=5\text{V}, R_L=350\Omega,$ $C_L=15\text{pF}$	-	30	-	ns
Fall time	$t_f$		-	5	-	ns
High level Common Mode Transient Immunity	$CM_H$	$I_F=0\text{mA}, V_{CC}=5\text{V}$ $V_{CM}=1000\text{V}, V_O(\text{Min})=2.0\text{V}$ $R_L=350\Omega$	10,000	-	-	V/us
Low level Common Mode Transient Immunity	$CM_L$	$I_F=7.5\text{mA}, V_{CC}=5\text{V}$ $V_{CM}=1000\text{V}, V_O(\text{Max})=0.8\text{V}$ $R_L=350\Omega$	10,000	-	-	V/us

● **Recommended Operating Conditions**

Parameter	Symbol	Min	Max	Unit
Low level input current	I <sub>FL</sub>	0	250	μA
High level input current	I <sub>FH</sub>	6	15	mA
Supply voltage	V <sub>CC</sub>	2.7	3.6	V
		4.5	5.5	
Fan out (TTL load )	N	-	5	-
Operating temperature	T <sub>opr</sub>	-40	+110	°C

### ● Characteristics Curves

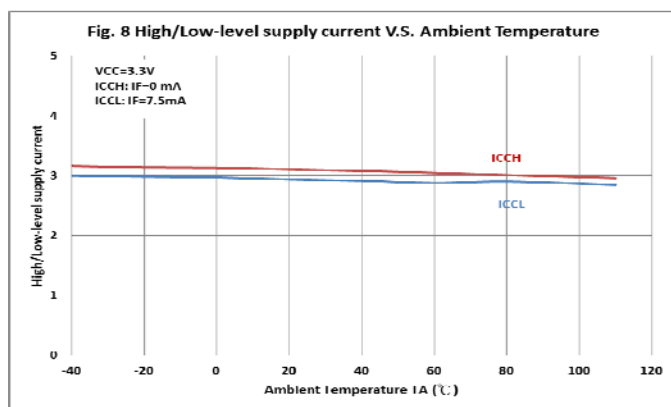
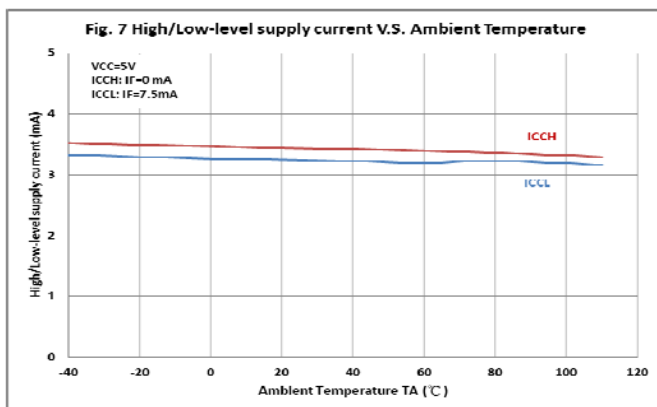
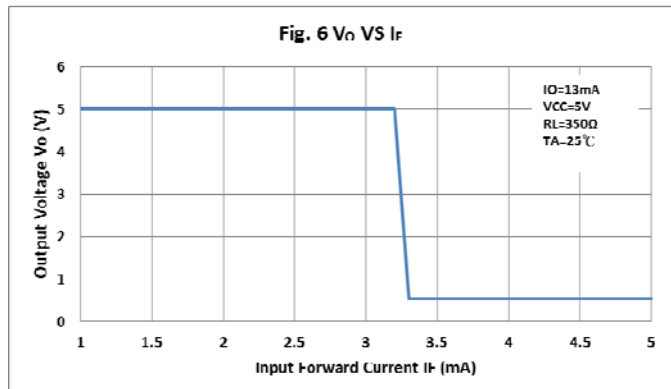
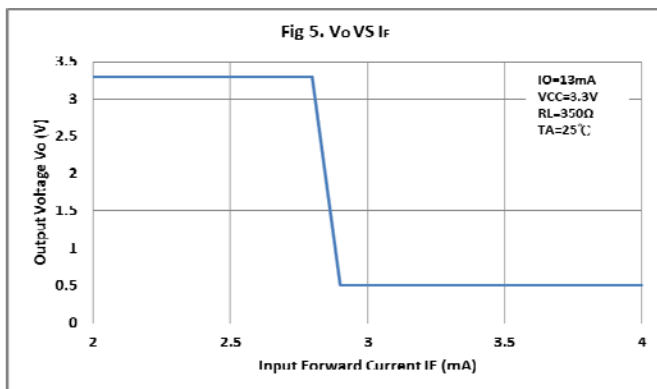
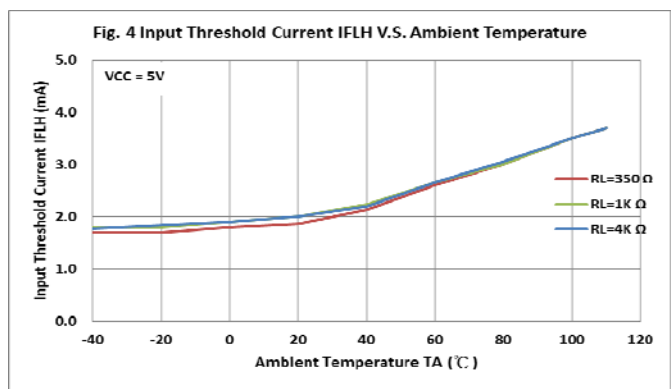
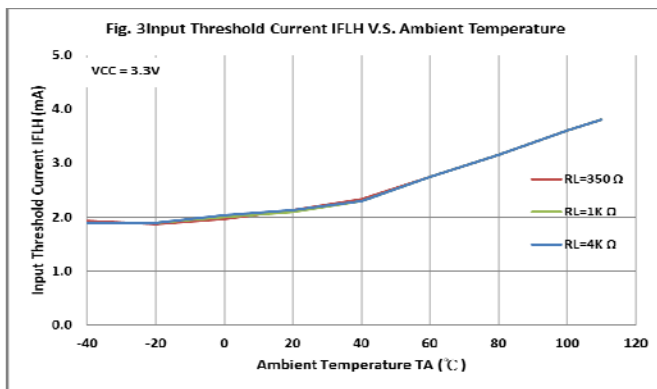
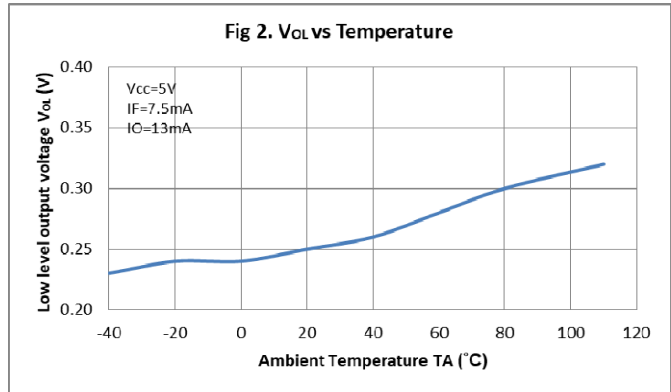
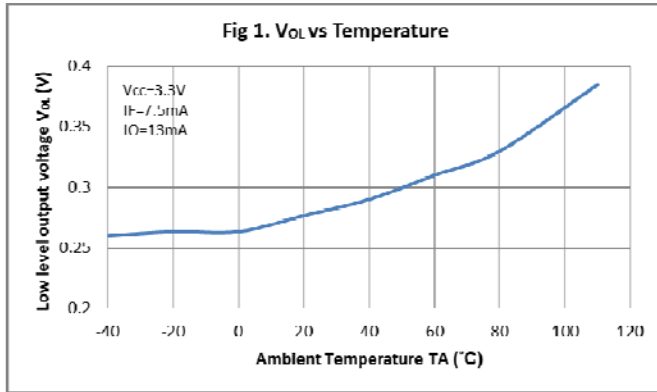

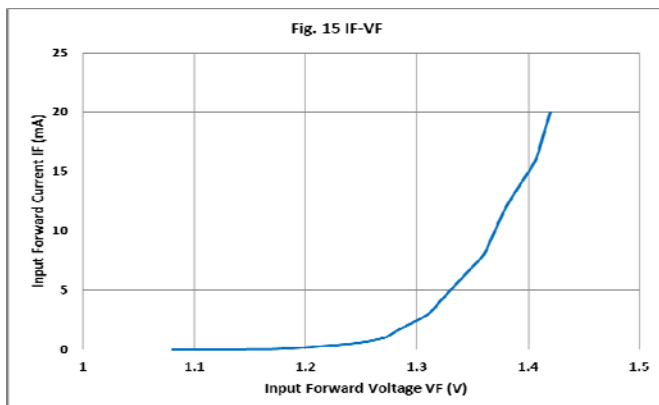
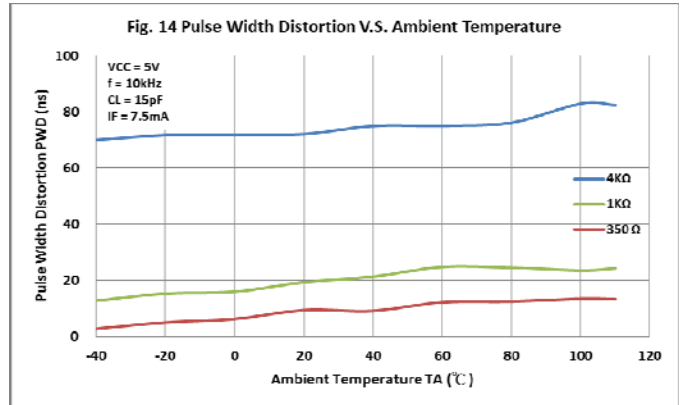
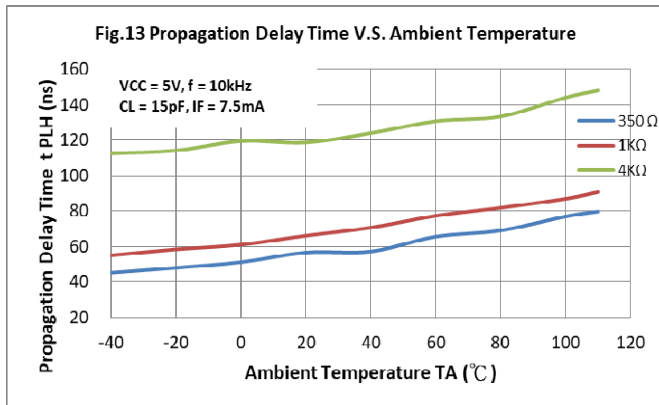
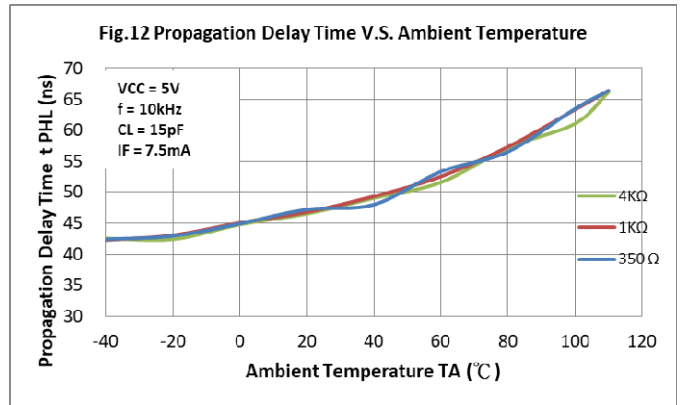
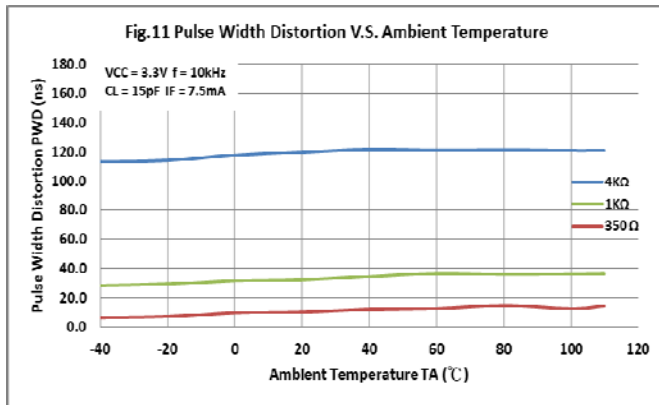
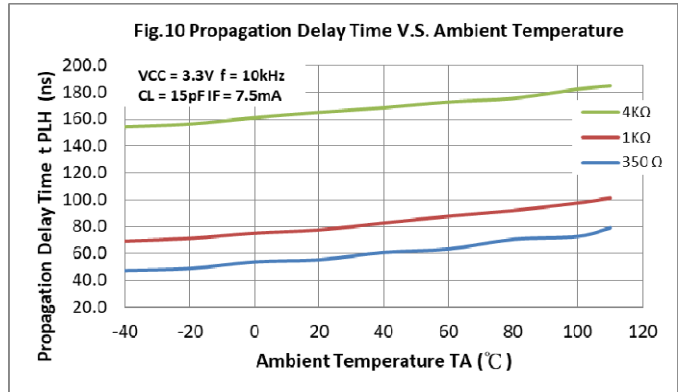
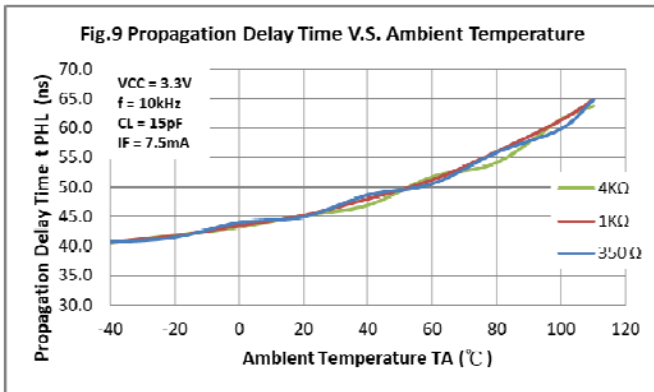



● **Test Circuit for Propagation Delay time**

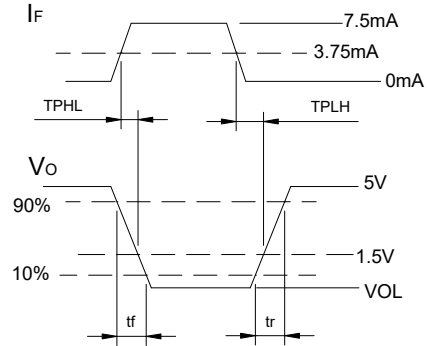
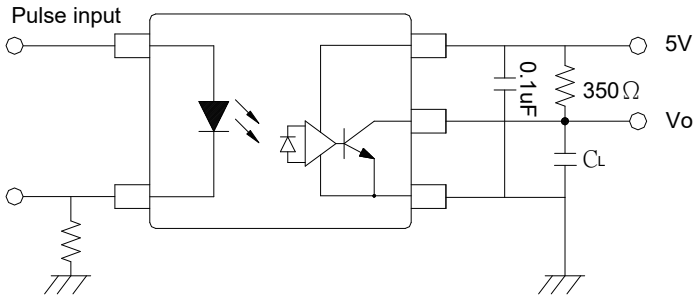

● **Test Circuit for Instantaneous Common Mode Rejection Voltage**

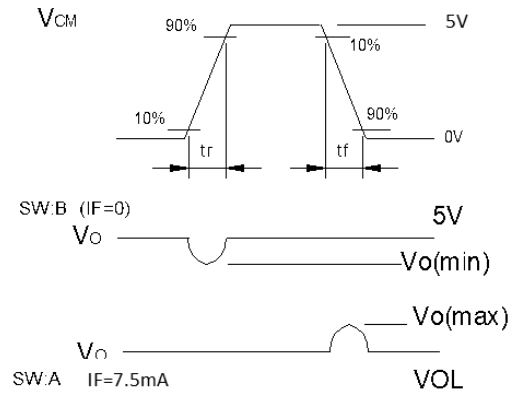
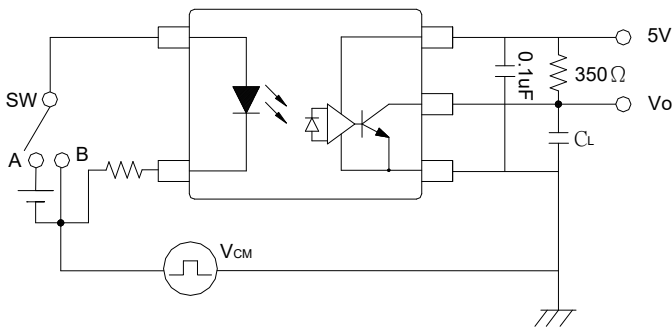

● **Recommended Soldering Conditions**

**(a) Infrared reflow soldering :**

- Peak reflow soldering : 260°C or below (package surface temperature)
- Time of peak reflow temperature : 10 sec
- Time of temperature higher than 230°C : 30-60 sec
- Time to preheat temperature from 180~190°C : 60-120 sec
- Time(s) of reflow : Two
- Flux : Rosin flux containing small amount of chlorine (The flux with a maximum chlorine content of 0.2 Wt% is recommended.)

**Recommended Temperature Profile of Infrared Reflow**

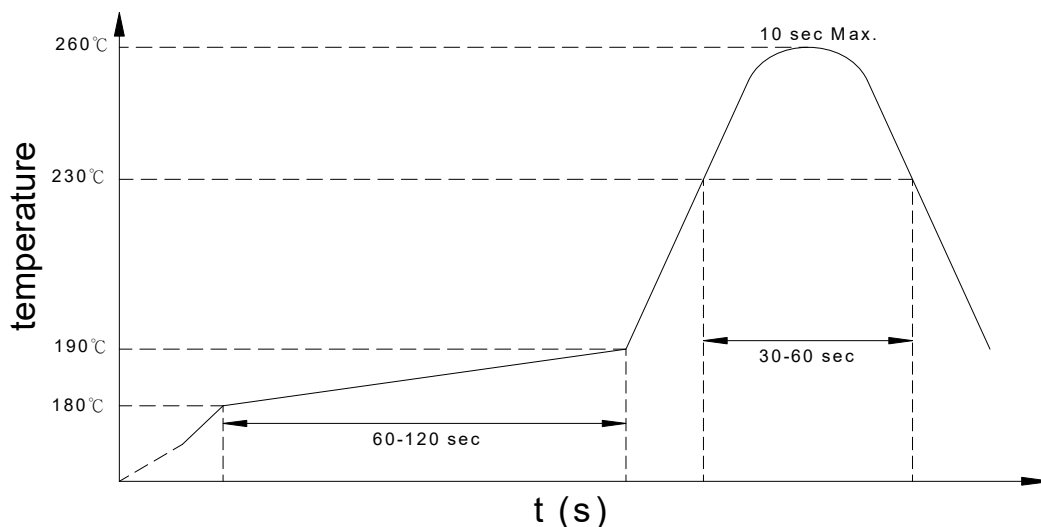

**(b) Wave soldering :**

- Temperature : 260°C or below (molten solder temperature)
- Time : 10 seconds or less
- Preheating conditions : 120°C or below (package surface temperature)
- Time(s) of reflow : One
- Flux : Rosin flux containing small amount of chlorine (The flux with a maximum chlorine content of 0.2 Wt% is recommended.)

**(c) Cautions :**

- Fluxes : Avoid removing the residual flux with freon-based and chlorine-based cleaning solvent.
- Avoid shorting between portion of frame and leads.

● **Numbering System**

**KPC611 (Z)**

**Notes:**

KPC611 = Part No.

Z = Tape and reel option (TLD, TRU)

Option	Description	Packing quantity
TLD	TLD tape & reel option	3000 units per reel
TRU	TRU tape & reel option	3000 units per reel

● **Recommended Pad Layout for Surface Mount Lead Form**

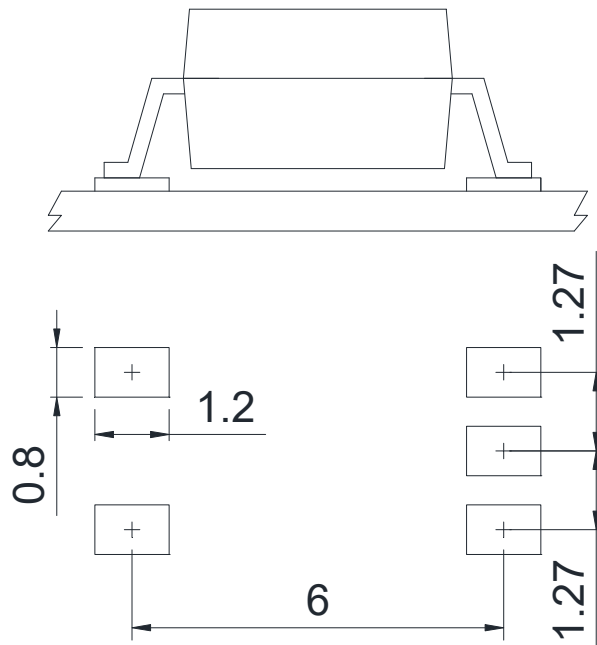

Unit : mm

● SOP Carrier Tape & Reel

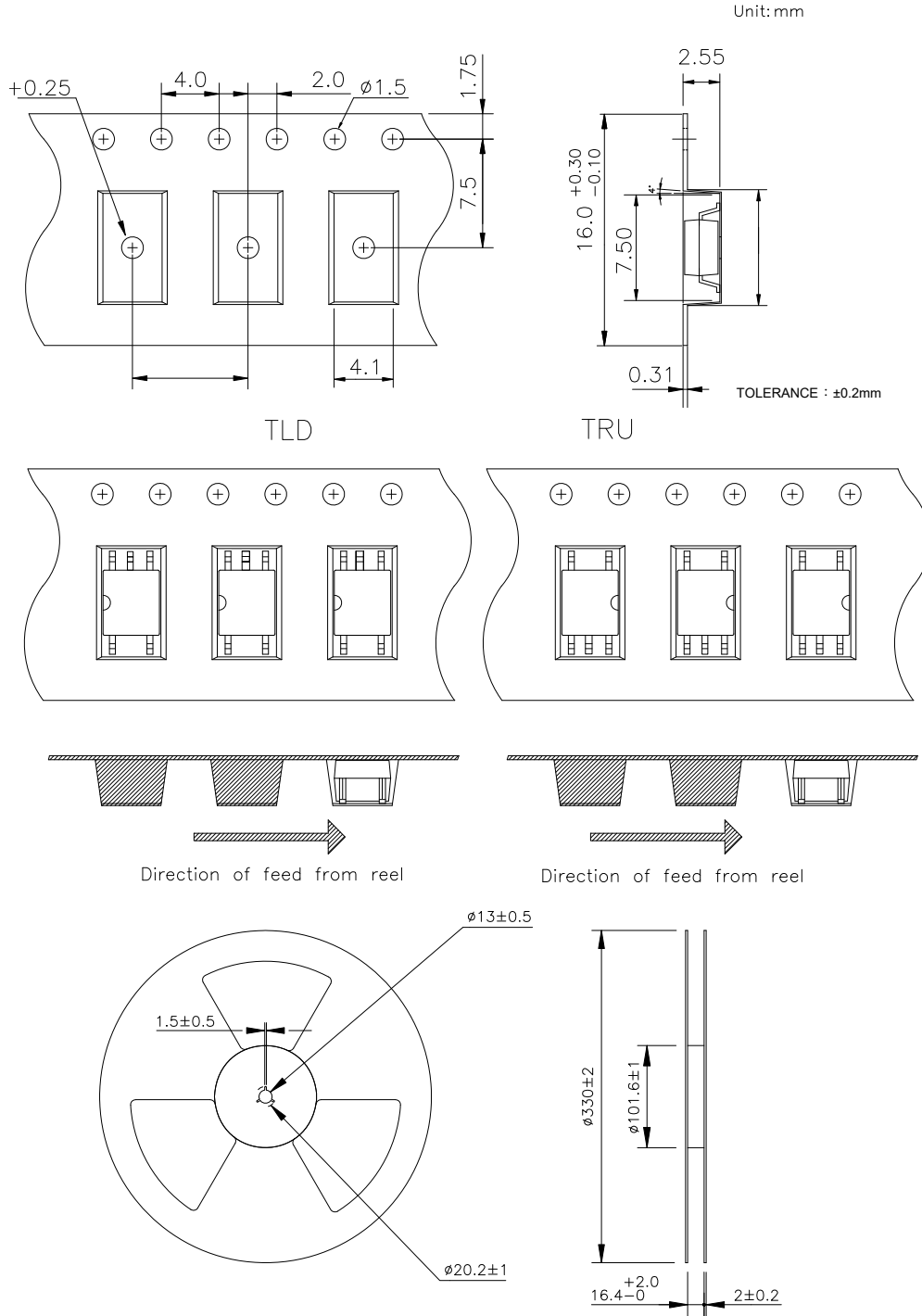

- **Application Notice**

The statements regarding the suitability of products for certain types of applications are based on cosmo's knowledge of general applications of cosmo products. Such statements are not binding statements about the suitability of products for a particular application. It is the customer's responsibility to verify the specifications are suitable for use in a particular application. Customers are solely responsible for all aspects of their own product design or applications. The parameters provided in the datasheet may vary in different applications and performance may vary over time. All operating parameters (including typical parameters) must be validated by customer's technical experts for different applications. cosmo assumes no liability for customer' product design or applications. Product specifications do not expand or otherwise change cosmo's terms and conditions of purchase, including but not limited to the warranty expressed therein.

When using cosmo products, please comply with safety standards and instructions. cosmo has no liability and responsibility to the damage caused by improper use of the instructions specified in the specifications.

cosmo products are designed for use in general electronic equipment such as telecommunications, office automation equipments, personal computers, test and measurement equipments, consumer electronics, industrial control, instrumentation, audio, video.

cosmo devices shall not be used in equipment that requires higher level of reliability and safety, such as nuclear power control equipment, telecommunication equipment(trunk lines), space application, medical and other life supporting equipments, and equipment for aircraft, military, automotive or any other application that can cause human injury or death.

cosmo reserves the right to change the specifications, data, characteristics, structure, materials and other contents at any time without notice. Please contact cosmo to obtain the latest specification.

cosmo disclaim any and all liability for any errors, inaccuracies or incompleteness contained in any datasheet or in any other disclosure relating to any product.